

GP Component

REV.	ECN NO.	LOCATIONS	DESCRIPTION	DATE	DESIGN
A0			原始版本 (INITIAL EDITION)	2021.3.12	LIUCHUN

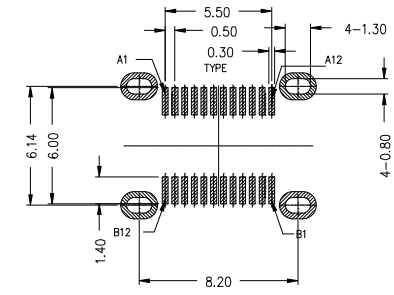
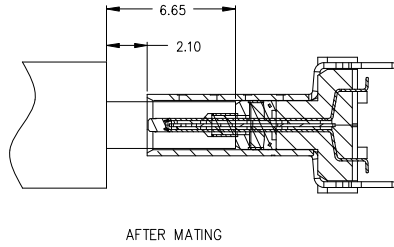
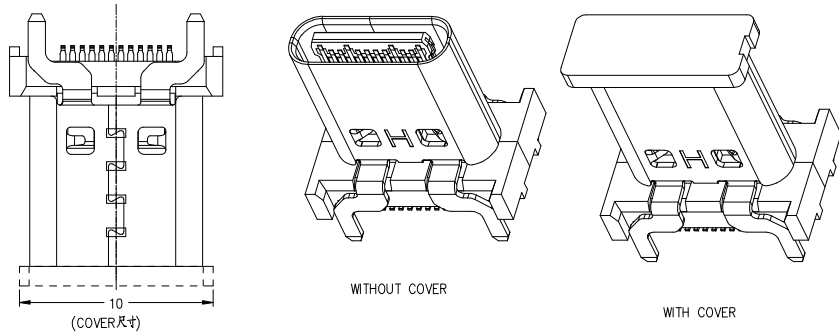

RECOMMEND P.C.B LAYOUT(COMPONENT SIDE)

TOLERANCE FOR PCB LAYOUT IS ± 0.05

KEEP OUT AREA

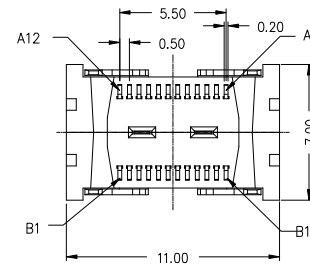
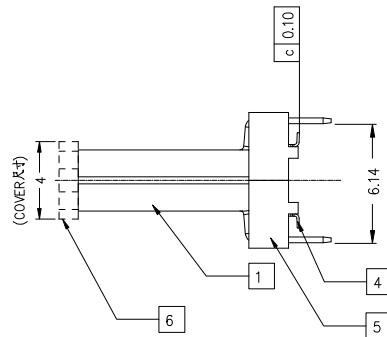
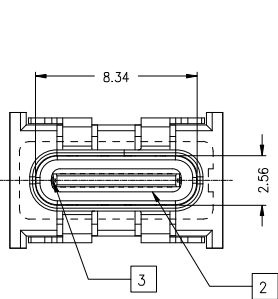

A4Q2403-P-XX-R

Mating Area plating

- 01: Au 1u"Min.
- 03: Au 3u"Min.
- 05: Au 5u"Min.
- 10: Au 10u"Min.
- 15: Au 15u"Min.
- 30: Au 30u"Min.

- 1.Contact Resistance: 40mOHM Max.;
- 2.Dielectric Withstanding Voltage:100V AC For 1 Minute;
- 3.Insulation Resistance:100M OHM Min.;
- 4.Mating And Unmating Force:
Mating Force: 5~20N
Unmating Force: 8~20N; 6~20N AFTER TEST;
- 5.Durability:10000 Cycles;

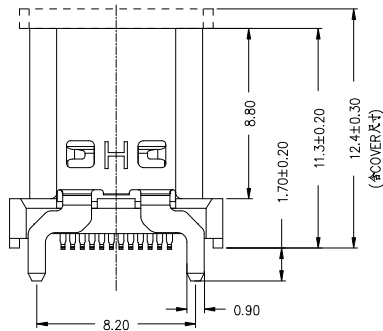

USB TYPE-C PIN ASSIGNMENTS

PIN NUMBER	SIGNAL NAME
A1	GND
A2	TX1+
A3	TX1-
A4	V bus
A5	CC1
A6	D+
A7	D-
A8	SBU1
A9	V bus
A10	RX2-
A11	RX2+
A12	GND

PIN NUMBER	SIGNAL NAME
B12	GND
B11	RX1+
B10	RX1-
B9	V bus
B8	SBU2
B7	D-
B6	D+
B5	CC2
B4	V bus
B3	TX2-
B2	TX2+
B1	GND

Item	Title	Material	Dispose	Q'TY
1	Shell	Stainless Steel	Ni:30u" Min.	1PCS
2	GND Plate	Stainless Steel		2PCS
3	Mid Plate	Stainless Steel		1PCS
4	Contact	Copper Alloy	Mating Area: See P/N Solder Tails: Matt Tin	24PCS
5	InsertMolding	High Temperature Plastic	UL 94V-0 Black	1PCS
6	COVER	High Temperature Plastic	UL 94V-0 Black	1PCS



东莞市韩晶电子有限公司

TOLERANCE: X. ±0.35 X.X ±0.25 X.XX ±0.15 X.XXX ±0.10 X' ±2' X.X' ±1.5'	DESIGN BY :	DATE :	PART NAME:
	LIUCHUN	2021.3.12	USB 3.1 TYPE C FEMALE VERTICAL H11.3mm SMT TYPE
 UNIT: mm SCALE: 1:1 SIZE: A4	CHECKED BY:	DATE :	PART NO.
			A4Q2403-P-XX-R
	APPROVED BY:	DATE :	MOLD NO.
			NA
			DRAW NO.
			SHEET NO.
			01 OF 01